



Use only for initial deployment.
For node replacement, see **zTC Edge 110i Systems: Replacing a Node.**

User-supplied Components



Monitor (HDMI)



Keyboard (USB)



Network cables (2)



Networked PC or laptop



1/8" Slotted screwdriver (if mounting)



#2 Phillips screwdriver (if mounting)

**Contact network administrator for settings.
If using DHCP, only static System IP address required.**

System IP address (static required) _____ . _____ . _____ . _____

Node0 IP address _____ . _____ . _____ . _____

Node1 IP address _____ . _____ . _____ . _____

Gateway address _____ . _____ . _____ . _____

Network mask _____ . _____ . _____ . _____

DNS servers _____ . _____ . _____ . _____

(System and node IP addresses must be on same subnet.)

New admin password _____

Stratus Components

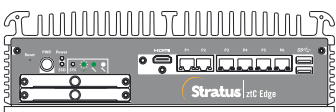

zTC Edge nodes (2)



Power cables (2)



Power adapters (2)



Power adapter DIN/wall mount plates (2)

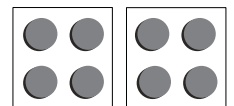

Rubber feet (8)



Network cables (blue and yellow)

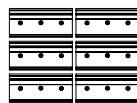

zTC Edge DIN rail mount brackets (6)

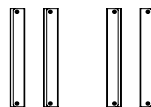

zTC Edge wall mount brackets (4)



M3*4L flat-head Phillips-head screws (18)



M3*5L round-head Phillips-head screws (8)

For zTC Edge Release Notes and documentation, please visit <http://ztcgedoc.stratus.com>.
To access other zTC Edge self-help resources, including Knowledge Base articles and software downloads, visit Stratus Customer Service at <http://www.stratus.com/support>.

1 Connect keyboard and monitor to one node, then connect power.

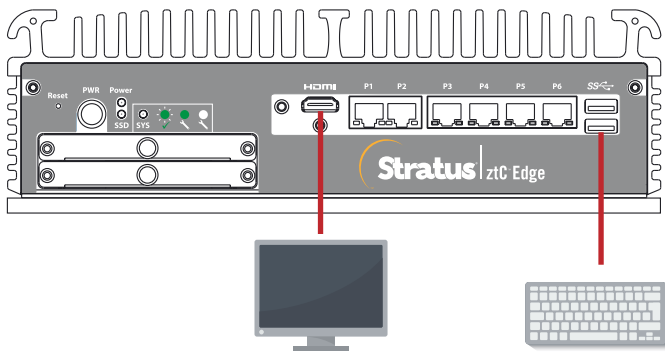

Node (front)

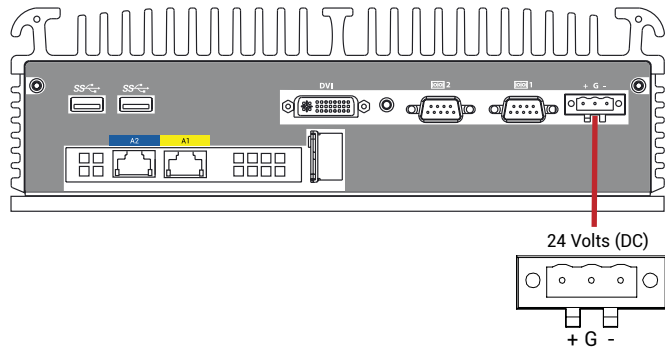

Node (rear)

2 Node powers on automatically. If not, press power button. Wait for node to boot, then follow on-screen instructions. (Node might beep while booting, which is normal.)

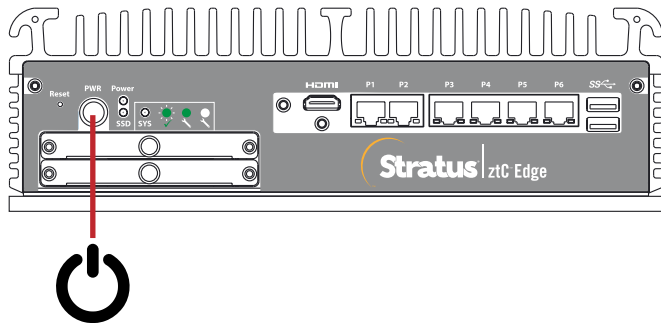

Node (front)



3 When instructed, connect P1 port of each node to your existing LAN, and connect blue and yellow network cables from first node to second node (A2 and A1 ports). Connect power to second node and verify that it powers on.

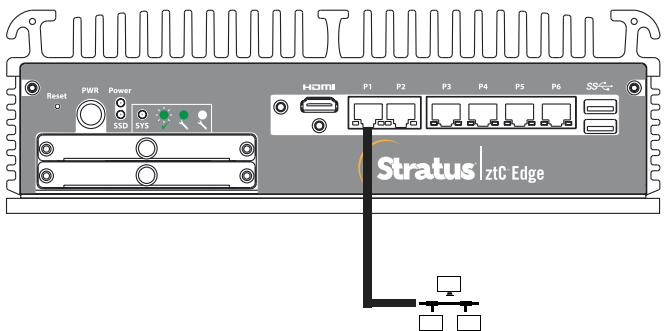

Node (front)

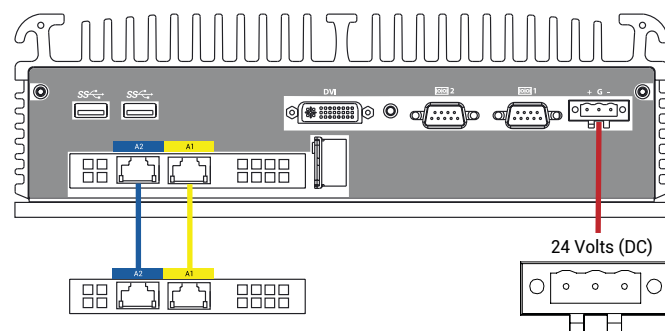

Node (rear)

4 Wait up to 15 minutes for system to display `https://nnn.nnn.nnn.nnn` address, and for SYS LED to blink on both nodes. Record address for step 5.

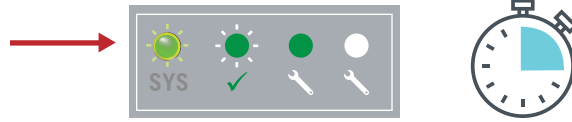
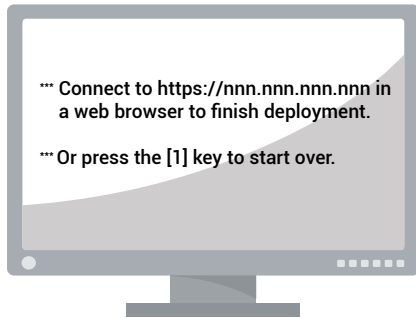

`https://_._._. _._._. _._._. _._._`

5 On networked PC or laptop, open web browser and enter address from step 4 to continue configuring system. If security message is displayed, follow browser instructions to allow site to load. Log on with default username and password of **admin**. Complete **EULA** and **Config** screens.

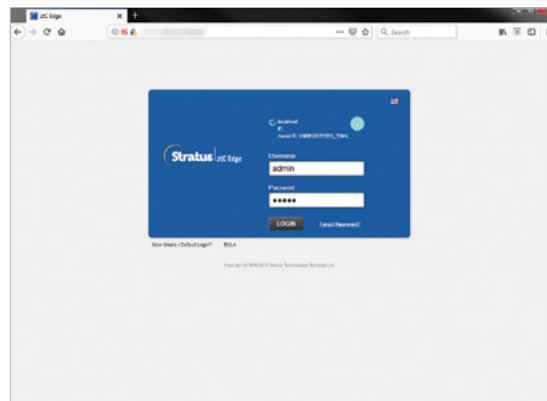

6 On **License** screen, follow link to register system and download permanent license key. See separate registration sheet for ASSET ID and instructions. Install license key on system and set new **admin** password to complete deployment.



Recommended

Before using system, ensure it is running latest software. See Release Notes for details and download software from <https://www.stratus.com/services-support/downloads>.

Optional

Disconnect keyboard and monitor for headless operation. On both nodes, fasten captive screws on power connectors using 1/8" slotted screwdriver.

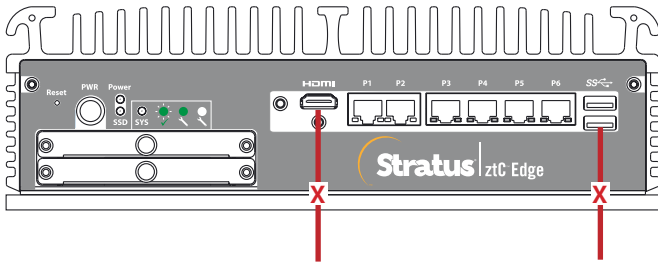

Node (front)

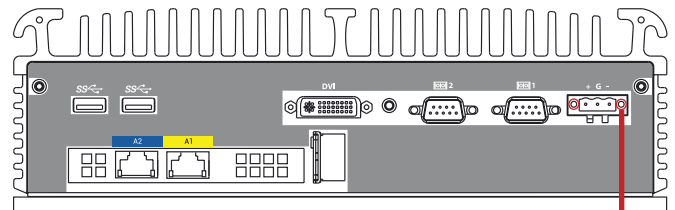

Captive screws

Node (rear)

Optional

Fasten DIN rail mount or wall mount to each node using #2 Phillips screwdriver. Or, install rubber feet for freestanding nodes only.

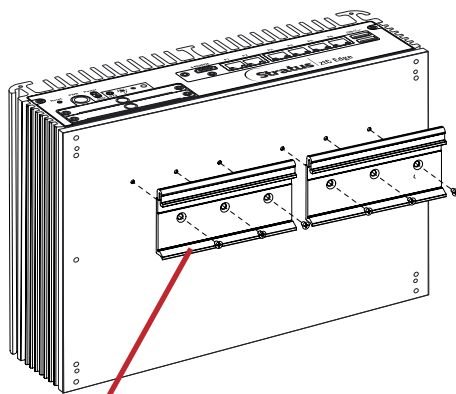

For DIN rail mount

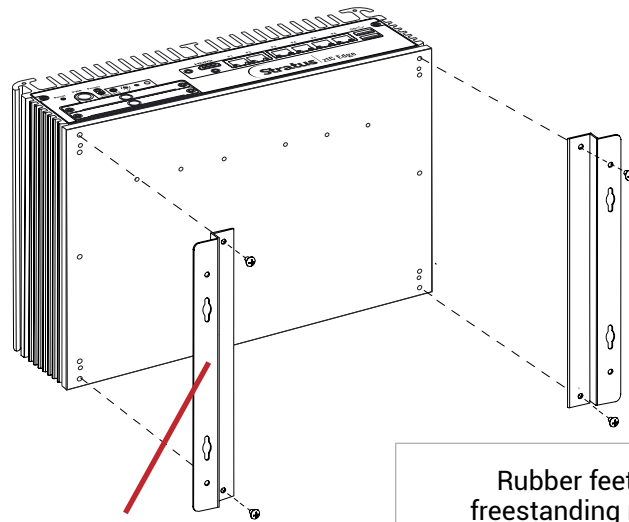

For wall mount

Rubber feet for freestanding nodes

